

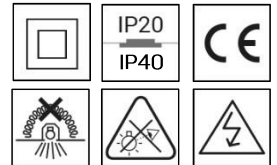

0341
0344
CEILING RECESSED

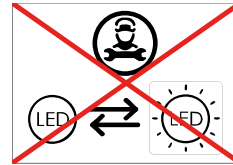
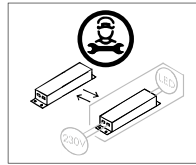

WARNING

ANY MODIFICATION TO THIS FITTING IS FORBIDDEN WITHOUT PRIOR AUTHORIZATION

Our policy is the constant improvement of the product. We reserve the right to modify the characteristics of the equipment without prior notice. Please refer to the website www.arcluce.it for this and other technical documents continually updated.

All information is presented in good faith. no responsibility may be imputed to us for errors, omissions or incorrect interpretations.

The photographs and drawings are within the limits of the quality of the printed reproduction, not binding and indicative only.



Directive 2002/96/CE (Waste Electrical and Electronic Equipment - WEEE). The crossed out wheeled bin label indicates that this product should not be disposed how the normal household waste stream, but with a separate collection; this in order to prevent potential negative consequences for the environment and the human health. For more details on available collection facilities please contact your local government office or the dealer where you purchased this product.

The safety and the proper functioning of the fitting is guaranteed only respecting the electrical Standards and this mounting instructions; therefore it's necessary to keep them.

Installation should be carried out by a suitable qualified person. Always refer to electrical data on the fixture label.

The light source of this luminaire is not replaceable; when the light source reaches its end of life, the entire luminaire must be replaced. Only use original ARCLUCE spare parts.



Turn off power before maintenance (1)



Luminaires not suitable for covering with thermally insulating material (3).



Risk group 1 (IEC/TR62778). Do not stare at operating LED(2)

SPECIFICATIONS

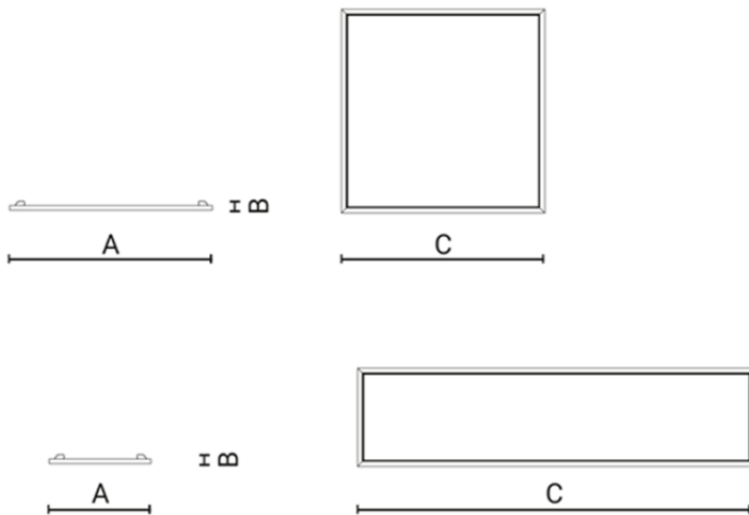

MECHANICAL

Dimensions:	A: 595 mm	A: 295 mm
	B: 8mm	B: 8mm
	C: 595 mm	C: 1195 mm

Weight: 0.7 / 1 / 1.2 Kg

Rated Ta: -20°C ~ +25°C

ELECTRICAL

Wiring: ON/OFF, ON/OFF-EM
DALI, DALI-EM

Input: 220-240V 50/60Hz

ACCESSORIES

1099495X



Ceiling box:
595 x 595 mm

1099496X



Ceiling box:
295 x 1195 mm

1099497X



Recessed box:
595 x 595 mm

1099498X

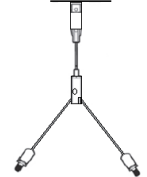

Suspension kit.

INSTALLATION

1. Perform necessary cut-out in the false ceiling with correct dimensions.
2. Remove LED driver cap. Wire the fixture according to the diagram.
3. Slide fixture in position through cut-out.

1

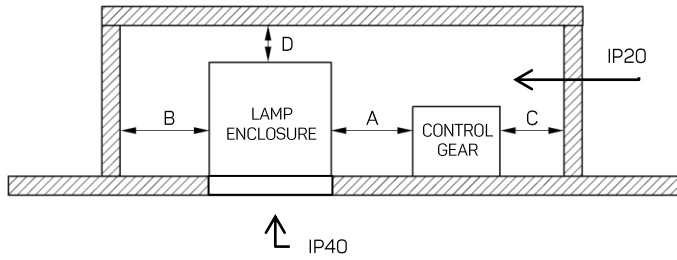

CLEARANCE (3)

A	0 cm
B	215 cm
C	215 cm
D	330 cm



The LED driver can be positioned on top of the fixture (1).

2

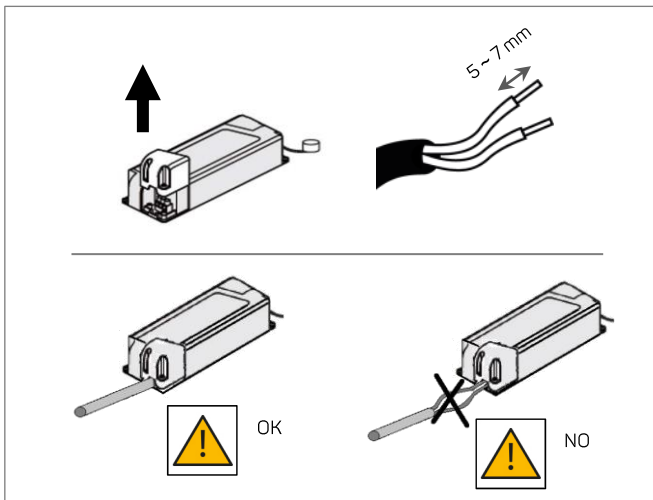

Turn off power (1).

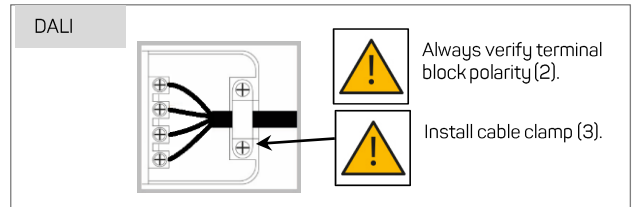
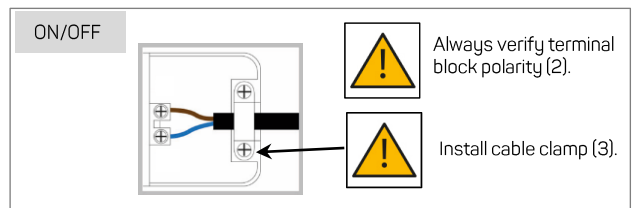
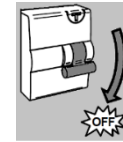

EMERGENCY

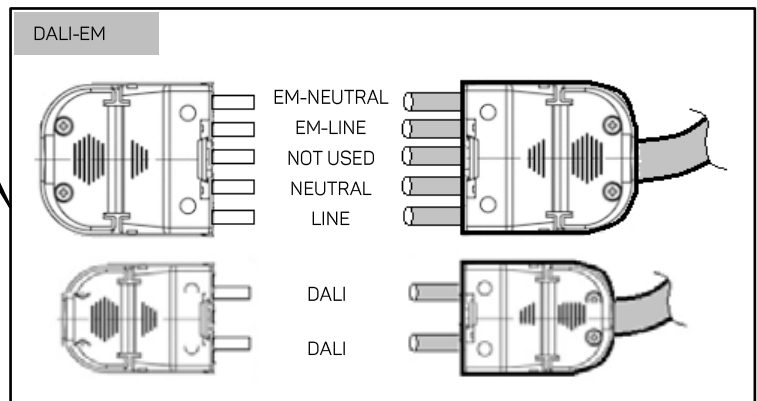
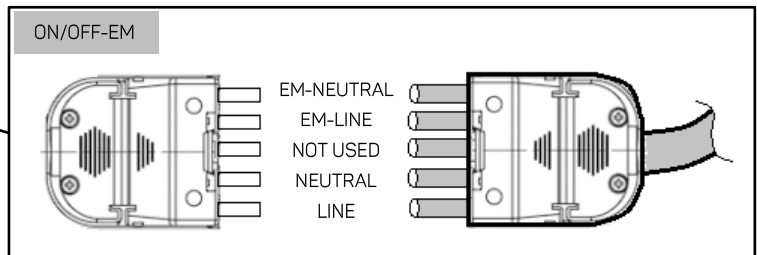
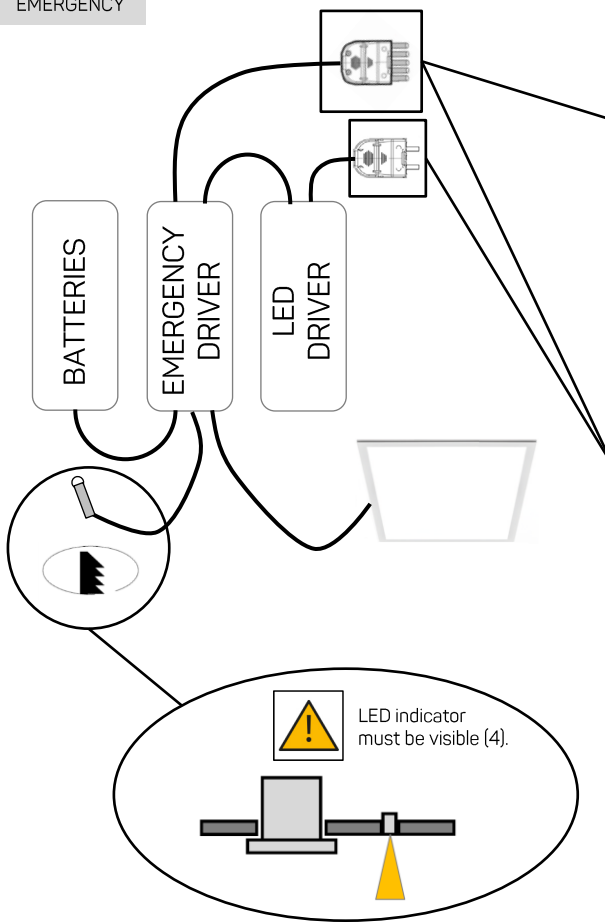

To be carried out by the installer or inspector
First use date (5).

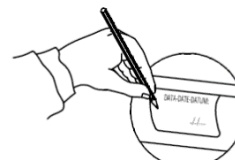

BATTERIES

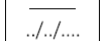

3



Connect the fixture to the driver before supplying the power (1).

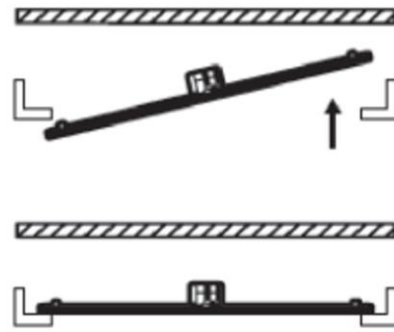
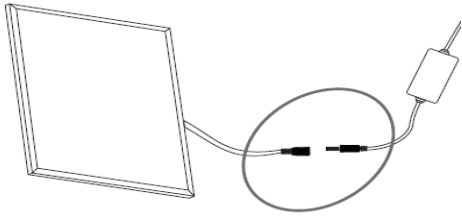

ACCESSORY

1099498X

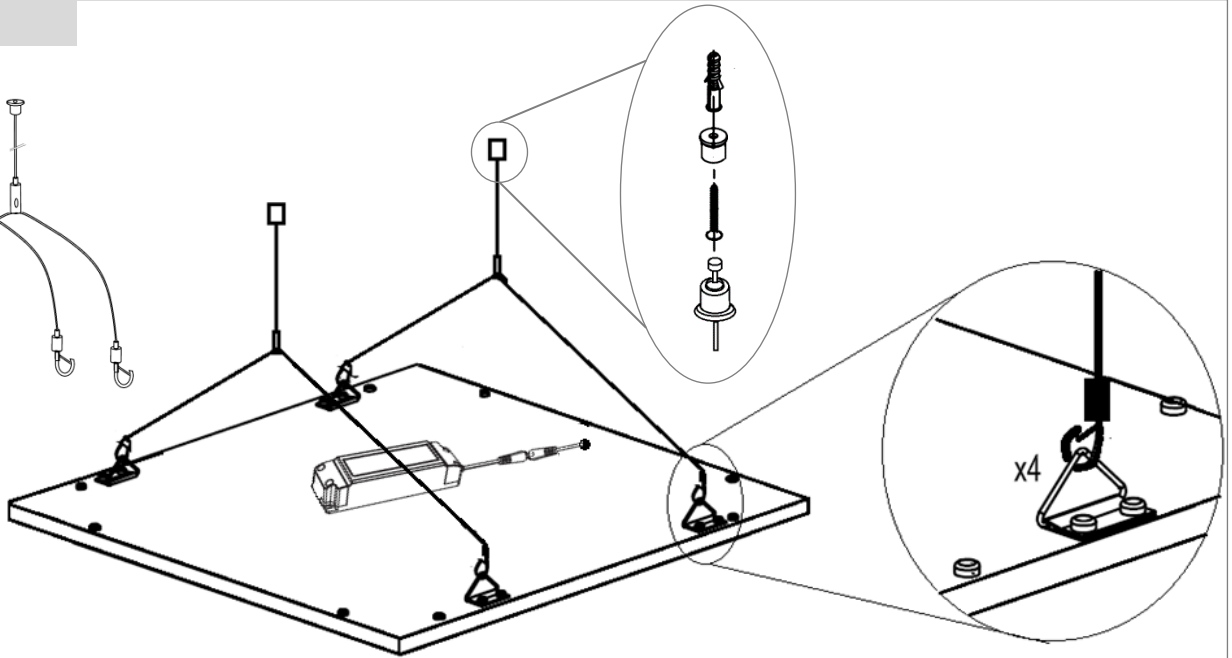
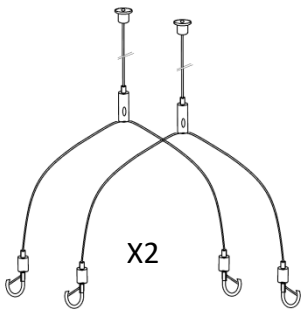

1099495X - 1099496X

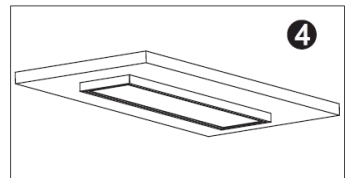
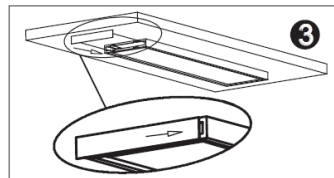
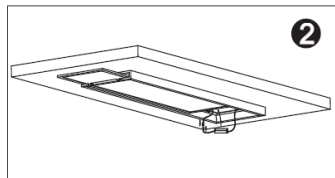
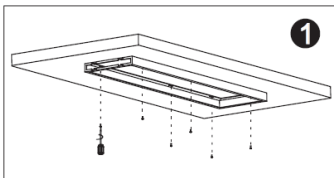
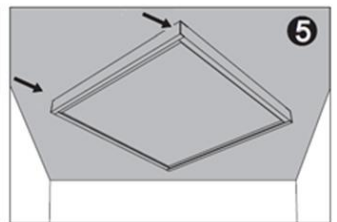
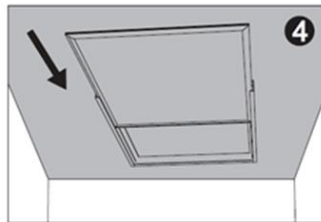
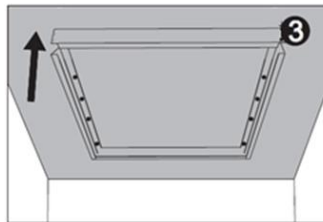
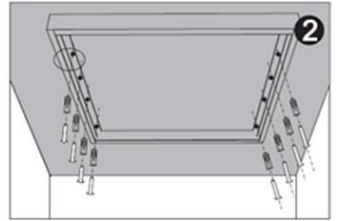
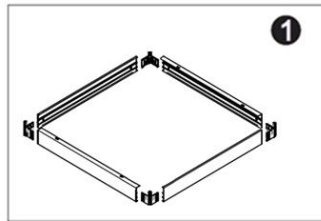
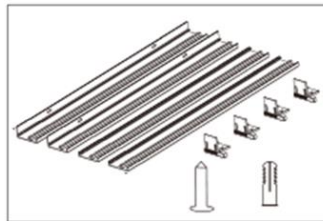
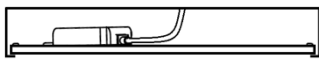

ACCESSORY

1099497X

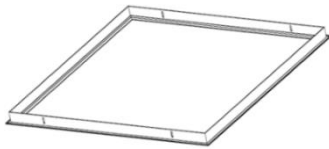

Cut-out: 615 mm

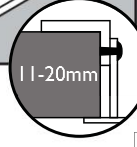
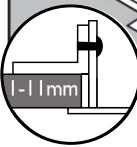
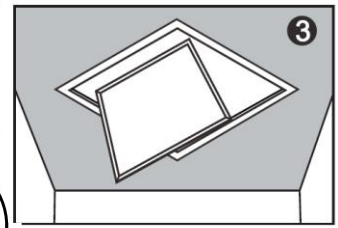
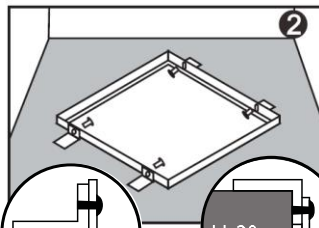
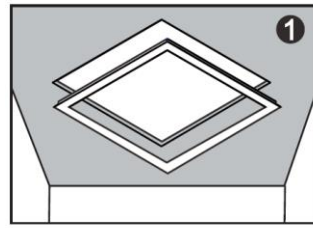

Allowed ceiling thickness: 1-20mm
(reverse brackets if the ceiling is thicker than 11mm).

AVERTISSEMENTS

TOUTE MODIFICATION DE CET APPAREIL, SANS AUTORISATION, EST INTERDITE

Notre politique est l'amélioration constante du produit. Nous nous réservons le droit de modifier les caractéristiques de l'équipement sans préavis. Veuillez-vous référer au site web www.arcluce.it pour cela et d'autres documents techniques continuellement mis à jour. Toutes les informations sont présentées de bonne foi, aucune responsabilité ne peut nous être imputée pour des erreurs, des omissions ou des interprétations incorrectes. Les photographies et les dessins sont dans les limites de la qualité de la reproduction imprimée, ils ne sont pas contraignants et à titre indicatif seulement.

Directive 2002/96/CE (Déchets d'Équipements Électriques et Électroniques - DEEE). L'étiquette de la poubelle à roulettes barrée indique que ce produit ne doit pas être éliminé comme les déchets urbains mais par une collecte séparée; ceci afin d'éviter des conséquences négatives potentielles sur l'environnement et la santé humaine.

Pour plus de détails sur les installations de collecte disponibles, veuillez contacter votre administration locale ou le revendeur auprès duquel ce produit a été acheté. La sécurité et le bon fonctionnement du luminaire sont garantis uniquement en respectant les normes électriques et les présentes instructions de montage; donc il est nécessaire de les garder. L'installation doit être effectuée par une personne qualifiée appropriée. Toujours se référer aux données électriques sur l'étiquette du luminaire. La source lumineuse de ce luminaire n'est pas remplaçable; lorsque la source lumineuse atteint sa fin de vie, l'ensemble du luminaire doit être remplacé. N'utilisez que des pièces de rechange ARCLUCE.

(1) Avant toute intervention sur l'appareil éteindre l'alimentation. (2) Groupe à risque 1 (IEC/TR62778). Ne regardez pas directement les DELs en fonction. (3) Ne pas couvrir les appareils avec un matériau thermiquement isolant.

INSTALLATION:

1. Effectuer la découpe nécessaire dans le faux plafond avec les dimensions correctes
2. Enlever le couvercle du driver LED. Câbler le luminaire selon le schéma
3. Faites glisser l'appareil en place à travers la découpe.

IMAGES:

(1.1) Le driver LED peut être positionné sur le dessus du luminaire. (2.1) Éteindre l'alimentation. (2.2) Vérifiez toujours la polarité du bornier. (2.3) Installez le serre-câble. (2.4) L'indicateur LED doit être visible. (2.5) À effectuer par l'installateur ou l'inspecteur. Date de première utilisation. (3.1) Connectez l'appareil au driver avant de le mettre sous tension.

AVVERTENZE

SONO VIETATE MODIFICHE ALL'APPARECCHIO SENZA AUTORIZZAZIONE

Perseguiamo una politica di costante miglioramento del prodotto. Ci riserviamo il diritto di modificare le caratteristiche dell'apparecchiatura senza preavviso. Si prega di fare riferimento al sito www.arcluce.it per questo e altri documenti tecnici che vengono continuamente aggiornati. Tutte le informazioni sono presentate in buona fede. Nessuna responsabilità ci può essere attribuita per errori, omissioni o interpretazioni errate. Le fotografie e i disegni sono nei limiti della qualità della riproduzione stampata, non sono vincolanti e solo per informazione.

Direttiva 2002/96/CE (Rifiuti di Apparecchiature Elettriche ed Elettroniche - RAEE). Il pittogramma del bidone con ruote barrato indica che questo prodotto non deve essere smaltito come normale rifiuto urbano ma attraverso raccolta separata; questo per evitare potenziali conseguenze negative per l'ambiente e la salute umana. Per i dettagli sulle strutture di raccolta disponibili, contattare l'ufficio governativo locale o il rivenditore presso il quale è stato acquistato il prodotto. La sicurezza e il corretto funzionamento dell'apparecchio sono garantiti solo rispettando le normative elettriche e queste istruzioni pertanto è necessario conservarle. L'installazione deve essere eseguita da personale qualificato fare sempre riferimento ai dati elettrici presenti sull'etichetta dell'apparecchio. La sorgente luminosa contenuta in questo apparecchio deve essere sostituita solo dal costruttore o dal suo servizio di assistenza o da personale altrettanto qualificato. Utilizzare solamente pezzi di ricambio originali ARCLUCE.

(1) Prima di qualsiasi intervento sul dispositivo, spegnere l'alimentazione. (2) Gruppo di rischio 1 (IEC/TR62778). Non osservare direttamente i LED in funzione. (3) Apparecchi non idonei ad essere ricoperti di materiale termicamente isolante.

INSTALLAZIONE

1. Eseguire l'apertura adeguata nel controsoffitto rispettando le dimensioni corrette
2. Rimuovere il coperchio del driver LED. Cablare l'apparecchio seguendo lo schema
3. Collocare l'apparecchio in posizione attraverso l'apertura.

IMMAGINI

(1.1) Il driver LED può essere posizionato sopra l'apparecchio. (2.1) Spegner l'alimentazione. (2.2) Verificare sempre la polarità dei morsetti. (2.3) Installare il serra-cavo. (2.4) L'indicatore LED deve essere visibile. (2.5) A cura dell'installatore o dell'ispettore. Data primo utilizzo. (3.1) Collegare l'apparecchio al driver prima di collegare l'alimentazione.